

7887 GRAVES DETACHEMENT

APO 757

Unknown Blossville X-196

Attached hereto are case papers for an approved unidentifiable case which are considered to be of investigative importance. Records of this headquarters indicate these case papers were not previously forwarded to OQIC for:

UNKNOWN X-196 Blossville

(POC) ST LAURENT

Handwritten notes and signatures in the top right corner, including a signature and some illegible text.

CONFIDENTIAL

HEADQUARTERS
COMMUNICATIONS ZONE
EUROPEAN THEATER OF OPERATIONS
UNITED STATES ARMY
Office of the Chief Quartermaster
APO 887

JMcG/gd

Q-GRE (Blosville E-1-3)

(S: 28 February 1945)
8 February 1945

SUBJECT: Report of Burial for
BESSEN, John, serial number unknown

TO : Graves Registration Officer Q.M. Section, Hq, Third
U.S. ARMY, APO 403, U.S. ARMY.

1. Inclosed is a true copy of Report of Burial received by this office for BESSEN, John, serial number and organization unknown.
2. This report cannot be forwarded to the Quartermaster General, Washington, D.C., lacking this information.
3. It is requested that this office be advised if deceased was a former member of your command, or if any additional information is available on this case.

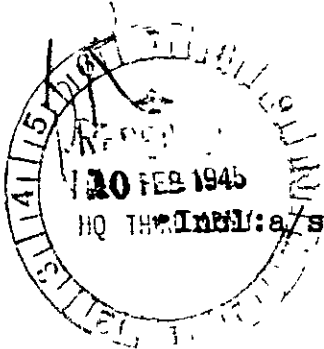

H. W. Bobrink
H.W. BOBRINK
Colonel, QMC
Chief, GR&E Div.

CONFIDENTIAL

*File
27 FEB 1945
H. W. Bobrink*

CONFIDENTIAL

AG 293 - GNMCQ-2
(8 February 1945)

1st Ind.

RECEIVED
12 FEB 1945
2019

HEADQUARTERS THIRD UNITED STATES ARMY, Office of the Quartermaster, APO 403, U. S. Army, 12 February 1945.

TO: Chief, Graves Registration and Effects Division, Office of the Chief Quartermaster, APO 867-A, U. S. Army.

1. A check of records at this headquarters revealed no information concerning John BESSEN.
2. His remains were buried prior to the time that this organization became operational. The First United States Army had control of Blossville Cemetery on 1 July 1944.

For the Quartermaster:

IN
14 FEB 1945
APO 887
YRE
Incl - h/e

Charles E. Hoy
CHARLES E. HOY,
Major, QMC,
Asst. GRO.

Q-GRE (Blossville E-1-3- 2nd Ind.

JMcG/gd

OCQM, HQ COM Z, ETO, APO 887, U.S. ARMY, 16 March 1945.

TO: Graves Registration Officer, Q.M. Section, Hq., First U.S. Army, APO 230, U.S. Army.

1. Your attention is invited to 2 paragraph, 1st Indorsement.
2. Request this office be advised of any information available.

Incl n/c

RECEIVED
19 MAR 1945
QM 53

H.W. Boerink
H.W. BOBRINK
Colonel, QMC
Chief, GR&E Div.

4

CONFIDENTIAL

CONFIDENTIAL

QM 293.960

3rd Ind

HEADQUARTERS FIRST UNITED STATES ARMY, APO 230, 26 MAR 1945

A TO: Commanding General, 90th Infantry Division.
(THRU: Commanding General, Third U.S. Army, APO 403.)

HEADQUARTERS THIRD ARMY

1. Subject deceased was reported as John Bessen from information contained in letter, Headquarters 357th Infantry Regiment, 24 June 1944, signed by 1st Lt. Roy G. Mosher, 357th Infantry Graves Registration Officer.

2. Request that Lt. Mosher be contacted for information as to what means were used to identify deceased as John Bessen.

For the Commanding General:

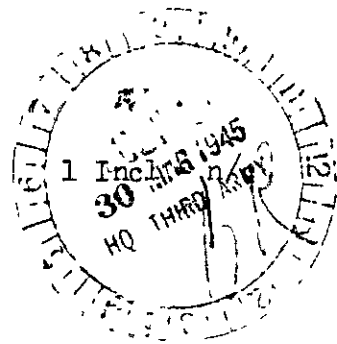

Joseph E Morrissey
JOSEPH E MORRISSEY,
Major, U. S. Army,
Asst Adjutant General

AG 293-GMTCQ-2
(8Feb 45)

4th Ind

CEH/pfh

HEADQUARTERS THIRD UNITED STATES ARMY, APO 403, U. S. Army, 1 Apr 45.

TO: CG, 90th Infantry Division, APO 90, U. S. Army.

For compliance with third indorsement.

By command of Lieutenant General PATTON:

H. A. Engler
H. A. ENGLER,
Capt., A. G. D.,
Asst. Adjutant General.

1 Incl n/c

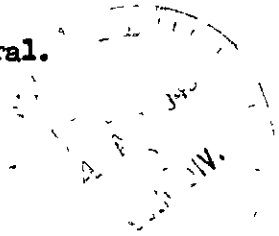

- 3 -
CONFIDENTIAL

AG 293 - GIMC -2

1st Inc.

/fck

(8 February 1945)

HEADQUARTERS THIRD UNITED STATES ARMY, Office of the Quartermaster,
APO 403, U.S. Army, 12 February 1945.

TO: Chief, Graves Registration and Effects Division, Office of the
Chief Quartermaster, APO 887-A, U.S. Army.

1. A check of records at this headquarters revealed no information
concerning John Bessen.

2. His remains were buried prior to the time that this organization
became operational. The First United States Army had control of
Elosville Cemetery on 1 July 1944.

For the Quartermaster:

CHARLES E. HOY,
Major, GIMC
Asst. GRO.

-GIMC (Elosville 1-1-3-

2nd Inc.

JMOG/gd

CGIMC, Hq. CGIMC, Hq., APO 887, U.S. Army, 16 March 1945.

TO: Graves Registration Officer, Hq. Section, Hq., First U.S. Army,
APO 230, U.S. Army.

1. Your attention is invited to 2 paragraph, 1st Indorsement.
2. Request this office be advised of any information available.

L. W. DURBIN
Colonel, GIMC
Chief, GRA&E Div.

Incl n/o

jmg

DISTRIBUTION:

pjw

- Orig & Dup - Addressee
- 1 Copy - L&R 887.
- 1 Copy - File GR&E
- 1 Copy - S. File

THM

GRE-HWB

BESSEN

AG 295 - GAO 1-2

1st Inc.

/fck

(8 February 1945)

HEADQUARTERS THIRD UNITED STATES ARMY, Office of the Quartermaster,
AGO 403, U.S. Army, 12 February 1945.

TO: Chief, Graves Registration and Effects Division, Office of the
Chief Quartermaster, AGO 887-1, U.S. Army.

1. A check of records at this headquarters revealed no information
concerning John B. Bessen.

2. His remains were buried prior to the time that this organization
became operational. The First United States Army had control of
Glosville Cemetery on 1 July 1944.

For the Quartermaster:

CHARLES L. HOY,
Major, AGO
Asst. GTC.

... ..
... ..
... ..
... ..
... ..
... ..

Incl 4/e

Dist: Distribution:
Orig & Dup - Addressee
1 Co - AGO 887.
1 Copy - File G&E (return to message)
1 Copy - C. File

THE
GR 1-11 B

AG 704. 5th Ind
(8 Feb 45)
HEADQUARTERS 90TH INFANTRY DIVISION, APO 90, U.S. Army, 4 Apr 45.

TO: Commanding Officer, 357th Infantry Regiment, APO 90, U.S. Army.
For compliance with 3rd indorsement.

BY COMMAND OF BRIGADIER GENERAL EARLEST:

1 Incl.
n/c

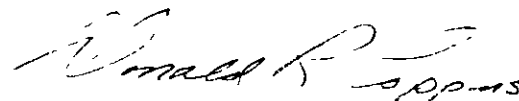

DONALD R. WOJG -
WOJG USA
Asst Adj. Gen

704 6th Ind. R21/mg
(8 Feb 45)
HEADQUARTERS, 357TH INFANTRY, APO 90, U. S. Army, 12 April 1945.

To: Commanding General, 90th Infantry Division,
APO 90, U. S. Army.

1. Subject soldier was one of a number of American dead buried by the enemy in a common grave in a small Normandy village church cemetery.

2. During this Regiment's operations in the sector, the grave was called to the attention of the undersigned in his capacity as Regimental Graves Registration Officer.

3. The parish priest was contacted and he gave the undersigned a list of the names of the men buried there. The source of the priest's information is unknown, except that he had in his possession the identification tags of several of the deceased.

4. All the information obtained was incorporated in the letter to which reference is made in preceding 3rd indorsement. No attempt was made in the letter at individual identification and it was suggested that the priest be contacted to assist in such identification when disinterment was accomplished.

5. The soldier was not a member of this command. From conversation with the priest, who spoke English only slightly, the impression was obtained that all the men were paratroopers. To the knowledge of the undersigned, the 82nd Division was the nearest airborne unit to operate to that sector. There is every probability that the name spelling may have been incorrect.

FOR THE REGIMENTAL COMMANDER:



ROY G. MOSHER Capt Inf
Assistant Adjutant

AG 704.

7th Ind

(8 Feb 45)

HEADQUARTERS 90TH INFANTRY DIVISION, APO 90, U.S. Army, 14 Apr 45.

TO: Commanding General, Third U.S. Army, Rear Echelon, APO 407, U.S. Army.

Attention is invited to preceding indorsement.

FOR THE COMMANDING GENERAL:

[Handwritten initials]
1 Incl.
n/c

1-11
AC 100
15 APR 1945

[Handwritten signature: Donald R. Coppins]
DONALD R. COPPINS
WOJG USA
Asst. Adj Gen

AG 293 - GVMCQ-2

8th Ind

/pjh

(8 Feb 45)

HEADQUARTERS THIRD UNITED STATES ARMY, APO 403, U. S. Army, 17 April 1945.

TO: CG, First United States Army, APO 230, U. S. Army.

[Handwritten signature: H.A.E.]
H.A.E.

1 Incl n/c

[Handwritten: Norman]

QM 293.960

9th Ind

HEADQUARTERS FIRST UNITED STATES ARMY, APO 230, 24 APR 1945

TO: Commanding General, 90th Infantry Division.
(THRU: Commanding General, Third U.S. Army, APO 403.)

Request information as to name and location of small Normandy village referred to in paragraph 1, 6th indorsement.

FOR THE COMMANDING GENERAL:

REC'D
1 Incl - n/c

FORWARDED
BY ARMY AGO
APR 24 1945

[Handwritten signature]
ADJUTANT GENERAL

HEADQUARTERS THIRD ARMY

B/L Hq 90th, APOUSA, file 2-386 (Elizaville I-1-3), subj: "Report of Burial for BASSAN, John, serial number unknown", dtd 3 Feb 45.

AG 293 - GMECQ-2 10th Ind /sam
(8 Feb 45)
HQ THIRD US ARMY, APO 403, US Army, 2 May 1945.

TO: CG, 90th Infantry Division, APO 90, US Army.
For compliance with preceding incorsement.

By command of General PATTON:

E. A. Engler
E. A. ENGLER,
Captain, A. G. D.,
Asst. Adjutant General.

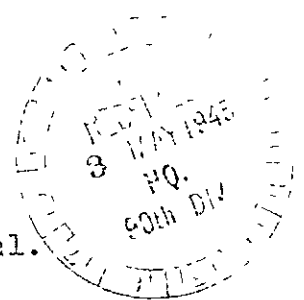

1 Incl:
n/c

AG 704. 11th Ind
(8 Feb 45)
HEADQUARTERS 90TH INFANTRY DIVISION, APO 90, U.S. Army, 3 May 45.

TO: Commanding Officer, 357th Infantry Regiment, APO 90, U.S. Army.
For compliance with 9th incorsement.

BY COMMAND OF BRIGADIER GENERAL EARLEST:

Donald R. Coppins
DONALD R. COPPINS
WOJG USA
Asst. Adj. Gen

1 Incl.
n/c

291-Bassan, John (L.I.) 12th Ind
(8 Feb 45)
HEADQUARTERS, 357TH INFANTRY DIV, APO 90, U. S. Army, 12 May 1945.

To: Commanding General, 90th Infantry Division,
APO 90, U. S. Army.

None of the village...

Elizaville, Kentucky, October 1944. 121070

FOR THE REPORT...

Roy S. Mosher
ROY S. MOSHER
Capt., 357th Infantry
Asst. Adjutant

1 Incl.
/c

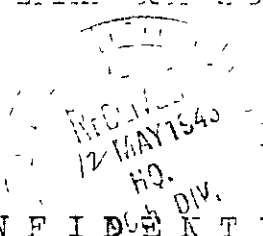

AG 201-Bessen, John (encl) 17th Ind
(8 Feb 45)
HEADQUARTERS 90TH INFANTRY DIVISION, APO 90, U.S. Army, 12 Nov 45.

TO: Commanding General, Third U.S. Army, Rear Echelon, APO 407,
U.S. Army.

Attention is invited to preceding indorsement.

FOR THE COMMANDING GENERAL:

RECEIVED
23 JUN 1945
AG MIL PASS
FOR THE COMMANDING GENERAL

RECEIVED
23 JUN 1945
AG MIL PASS
FOR THE COMMANDING GENERAL
H. A. ...
Adj. Gen

1 Incl.
n/c

AG 290 GIMCO-2 (Bessen, John) 14th Ind. /jak
(8 Feb 45)
HEADQUARTERS THIRD UNITED STATES ARMY, APO 400, US Army, 15 Feb 1945.

TO: Commanding General, Ninth U. S. Army, APO 339, U. S. Army.

RECEIVED
19 JUN 1945
H. A. ...
Adj. Gen

1 Incl; n/c

704.5 GNMAG-BC 15th Ind JLL/wec

HC NINTH UNITED STATES ARMY, APO 339, US Army, 13 June 1945.

TO: CG, European Theater of Operations, APO 887, US Army.
(Attn: OCQM)

1. Attention is invited to the preceding indorsements.
2. There is no record at this headquarters of subject soldier having been a former member of this command.

FOR THE COMMANDING GENERAL:

RECEIVED
22 JUN 1945
AG MIL PASS
FOR THE COMMANDING GENERAL

1 Incl
n/c

FREDERICK T. KINGDON
Captain, Infantry
Actg. Asst. Adj. Gen.

X

TOOTH CHART

Alcosville E-1-3

19 July 1945

Date

X-196

Unk.

Last Name

First

Initial

Unk.
Rank

Unk.
Serial No

Unit

Organization

Place of Death

Date of Death

Cause of Death

Right

Left

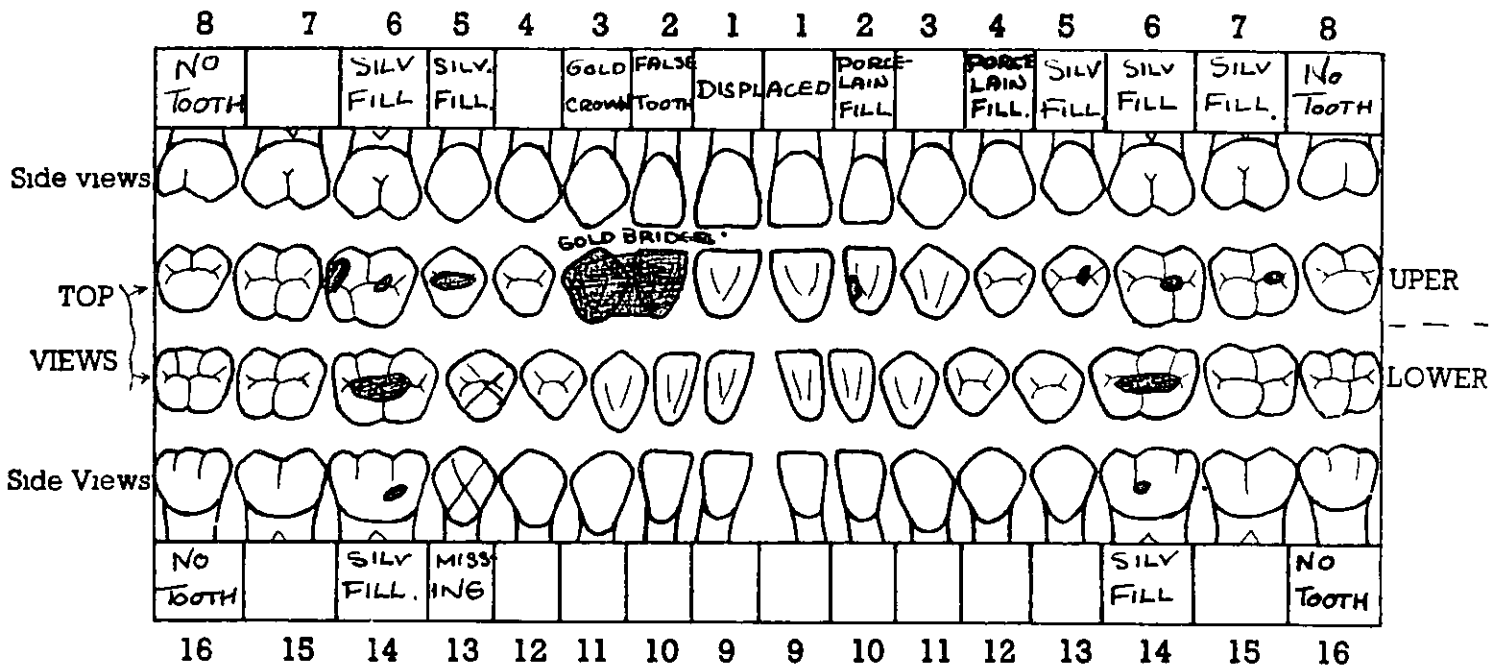

This dental chart is very important and should be filled in with great care. There are 32 teeth to be accounted for, as shown by the numbers on the chart. Beginning at the middle line in both upper and lower jaws, the teeth are arranged symmetrically on either side and classed as incisors (cutting teeth), cuspids or canines (tearing teeth), bicuspid (chewing teeth), and molars (principal chewing teeth). An examination should be made and findings charted to cover the following basic conditions: Lost teeth, crowned teeth, bridge work, fillings, caries (cavities of decay), dentures (plates), and any deformity of jaws found. See reverse side for illustrations.

No BR appears to be beginning of gold bridge with top of tooth displaced, evidently caries and anchor tooth.

Signature of Officer or other person who prepared Tooth chart

THOMAS L. PATSON'S

2nd Lt. INF

Verified by G R & Officer

MISSING TEETH. All teeth missing through previous extraction (not those fractured or displaced by recent wounds) should be "X" 'd out and labeled, thus .

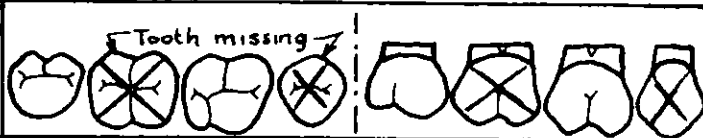

CROWNED TEETH. Block in solid the crown of tooth (label gold, porcelain, Silver or gold and porcelain), thus .

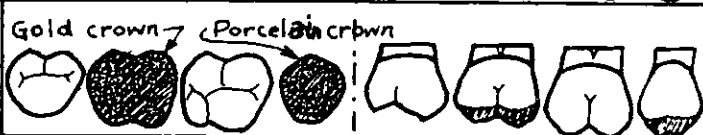

BRIDGE WORK. Block in solid the crown of tooth (label gold bridge, gold and porcelain bridge), thus

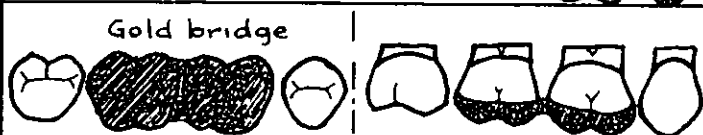

FILLINGS. Draw filling on tooth as accurately as possible (block in and label gold, silver, cement), thus

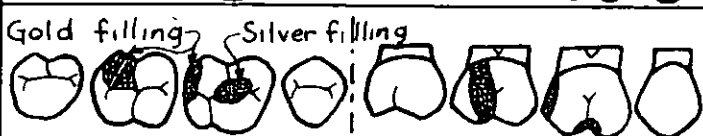

CARIES (CAVITIES) Outline location and size of cavity, shade in thus .

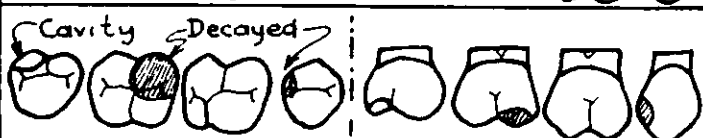

DENTURES (PLATES) Draw diagram of relative size and shape of plate, block in teeth attached and indicate retaining clasps on natural teeth with the word "clasp"

ADDITIONAL SPACE FOR FURTHER REMARKS

HEADQUARTERS
3058th QM Graves Registration Co
APO 502 U S ARMY

REPORT OF INVESTIGATION OF ISOLATED GRAVE

22 August 1945
U. S.

1. Name, Rank, ASN of deceased: Cross marked unknown allied Airman
2. Organization of deceased: Probably USAAF
3. Means of identification: none, pending investigation
4. Cause of death: Plane Crash b. Date of death: Approximately 23 July 4
6. If isolated grave:
a. Date of burial: 23 July 1944 b. By whom buried: Germans or English
c. Inscription on marker: Unknown allied Airman KIA 23 July 1944
7. Location of grave: In Apple orchard near Clinchamps-sur-Orne
see sketch (Sketch attached)
8. Names of deceased and location of other graves in immediate vicinity:
No others
9. Description and location of wrecked or abandoned vehicles or equipment in immediate vicinity: Aeroplane P 51 ass attached sheet
10. Disposition of personal effects: (Itemise if possible) _____
Investigation
11. Other pertinent information: see reverse side
(Use reverse side if necessary)
12. Information furnished by: RENE PORET
(Name, title, address) Poste De Clinchamps-sur-Orne
13. Names and addresses of other persons familiar with the case: _____

(OVER)

14. Action taken: Body disinterred and removed to an American Military Cemetery.
-
15. Disinterment approved by: Commanding Officer, 306 M Battalion, APO 562.
16. Disinterment made by: 4th Platoon, 3058th M Graves Registration Company.
17. Reburial made by: 4th Platoon, 3053rd M Graves Registration Company.
18. Date of reburial: 1 Sept 1945
19. Place of reburial: ~~St. Anne's American Military Cemetery~~ Alosville, France
- Plot _____ Row _____ Grave _____

~~MISSING IN ACTION~~
~~1945~~ - PA
~~O-116295~~

REMARKS

Rene Poret of Clincehamps stated that all the people left the village while the English and Germans were fighting there. After the town was liberated by the English they came back and he found the grave of this unknown aviator. Also the wreckage of the plane. No other information could be obtained from any one.

Thomas W. Parsons
 THOMAS W. PARSONS
 2nd Lt. INF

Description of and Numbers and Markings on Plane

Taken from Plate on Radiator in Front of Motor

North American Aviation Inc.
Ingelwood, California

AP. IN U.S. GALS.

MODEL

20

P. 51 B-5
Date

Material

250

INSPECTORS

Part No.

106-46002

Contract No.

AC. -30479

Date

Sereal No.

10655-1090

MOTOR No. 601918

Other Nos. found on Motor.

809821 --- 818609 --- 600 345

609820 --- A. 3251-H

Nos on oil Pan Plate.

D628 M

r 7 P 155

608 720

MAYTAG.

Nos from Plate on Side of Motor

Packard Built Rolls-Royce

AIR CORPS MODEL

V1650-3

Contract No.

W535-AC. 15678

Prop. Gear Ratio

477-1

Right Hand Tractor

AIR CORPS NO.

AF. 43-49331 ✓

MFRS. No.

B-267

ENG. SPEC No.

ACCEPTED

Blower Ratios.

6.391:1 and 8.095:1

Impeller Dias. 10.10 and 12.00

Normal Oil Pressure

70 to 90 lbs. Per. Sq. In.

Minimum Crusing Oil Pressure

60 Lbs. Per. Sq. In.

Comp. Ratio

6.0 to 1

Time Engin (Hot or Cold to

L.c -52 A.B.C.E.O. -72 BBC

With Valve Clearance at

.020 After Timing Engine

Change intake clearance

to .010 Spark advance
before T.C. Intake 50

Exhaust 50

A 123456

B 123456

Firing Order - 1A. -6B. -4A. -3B. -2A -5B -CA
1B. -3A. - 4B. -5A -2B

Packard Motor Car Company
Detroit, Michigan U.S.A.

TWO BROWNING MACHINE GUNS. CAL. 50M2 Found in Left Wing.

No. 391730 and 391715

Both Manufactured by Frigidare Division General Motors Corp.
Dayton, Ohio

Nos. on each of the four Propeller Blades

DWG. No J. 6523A - 24 Sereal No. 391854
DWG. No J. 6523A - 24 Sereal No. 391 Illegible, Probably (855)
DWG. No. J. 6523A - 24 Sereal No. 391856
DWG. No J. 6523A - 24 Sereal No. 391857

Both Sides of Fuselage Marked Thus.

Front to Rear.

C3 White

Star

Marking in Red Paint Slightly forward of
Cockpit on left side of Plane

Y
Pilot Lt. W. E. Bullard
Letters
C O -(Illegible) Easterly.
Letters
ABM. -(Illegible) man.

Not positive about
Letters with question
marks above them.

TOOTH CHART

1 September 1945

Unknown X-193 (Blossville American Military Cemetery) No. Unk.

Date Unk.

Last Name - First - Initial - Rank S AAF Serial No -

Unit Clinchamps-sur-Orne Organization Plane Crash

Place of Death - Date of Death 23 July 44 Cause of Death -

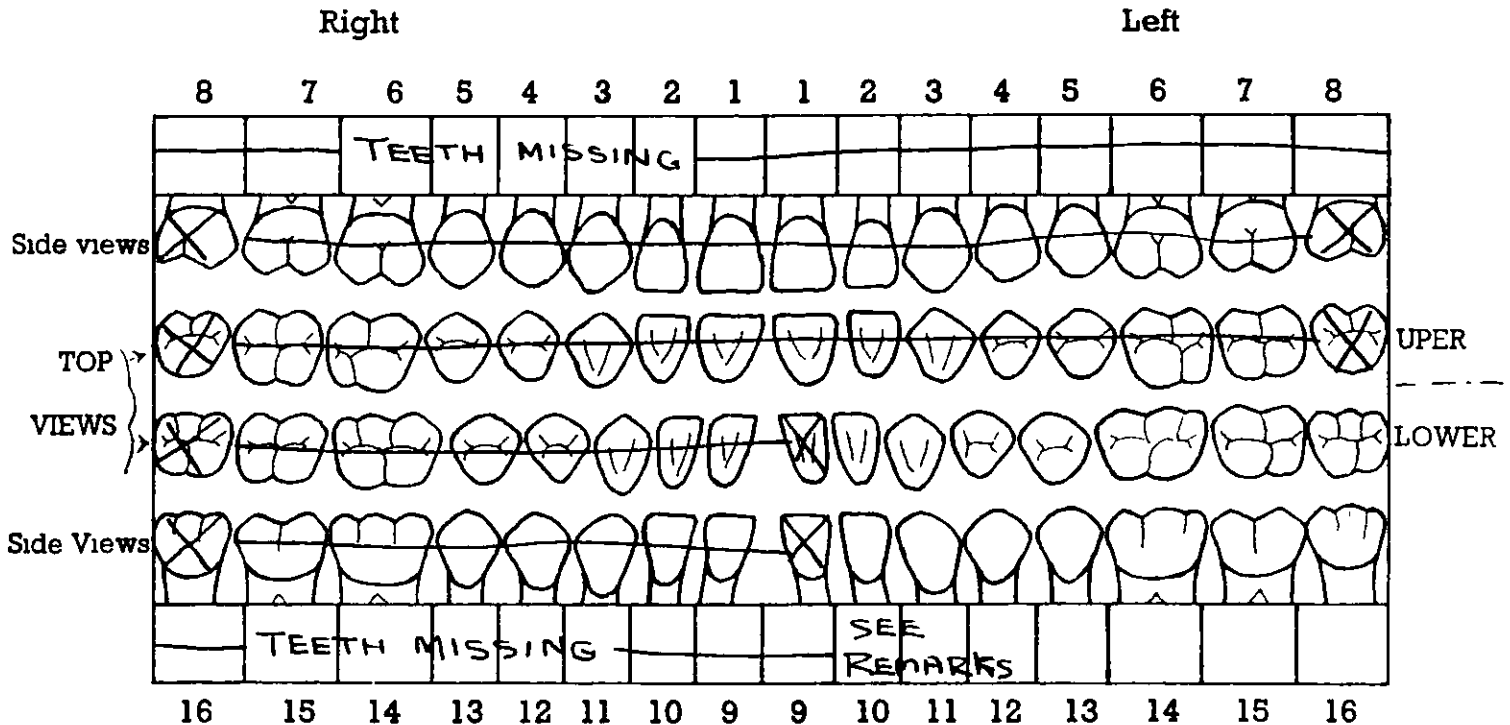

This dental chart is very important and should be filled in with great care. There are 32 teeth to be accounted for, as shown by the numbers on the chart. Beginning at the middle line in both upper and lower jaws, the teeth are arranged symmetrically on either side and classed as incisors (cutting teeth), cuspids or canines (tearing teeth), bicuspid (chewing teeth), and molars (principal chewing teeth). An examination should be made and findings charted to cover the following basic conditions: Lost teeth, crowned teeth, bridge work, fillings, caries (cavities of decay), dentures (plates), and any deformity of jaws found. See reverse side for illustrations.

Thomas I. Parsons

Signature of Officer or other person who prepared Tooth chart
 THOMAS I. PARSONS
 2nd Lt. INF
 Verified by G R S Officer

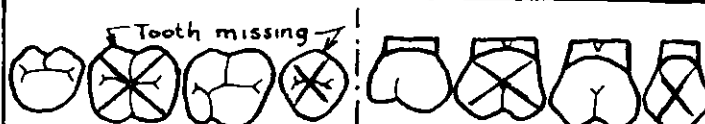
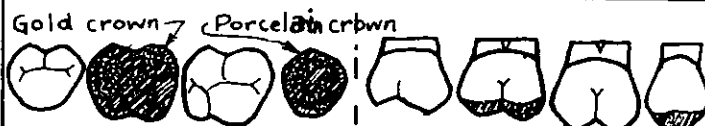
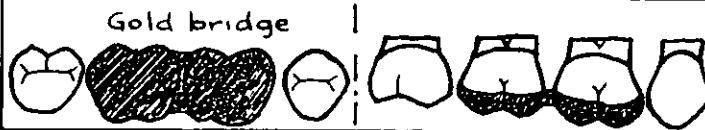
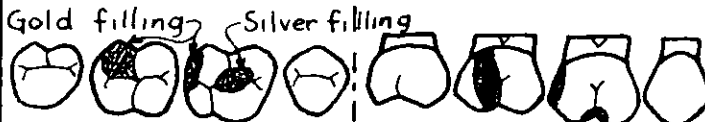
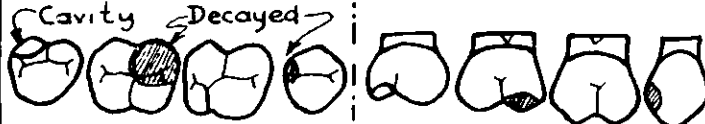
<p>MISSING TEETH All teeth missing through previous extraction (not those fractured or displaced by recent wounds) should be "X" 'd out and labeled, thus</p>	
<p>CROWNED TEETH. Block in solid the crown of tooth (label gold, porcelain, Silver or gold and porcelain), thus</p>	
<p>BRIDGE WORK. Block in solid the crown of tooth (label gold bridge, gold and porcelain bridge), thus</p>	
<p>FILLINGS. Draw filling on tooth as accurately as possible (block in and label gold, silver, cement), thus</p>	
<p>CARIES (CAVITIES) Outline location and size of cavity, shade in thus .</p>	

DENTURES (PLATES) Draw diagram of relative size and shape of plate, block in teeth attached and indicate retaining clasps on natural teeth with the word "clasp "

ADDITIONAL SPACE FOR FURTHER REMARKS

Lower left #10 & #11 Broken. Evidently the result of crash
 Only lower left portion of jaw found
 Lower 12-13-14-15-16 good condition

SKETCH SHOWING LOCATION OF GRAVE
AND WRECKAGE OF PLANE

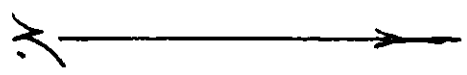
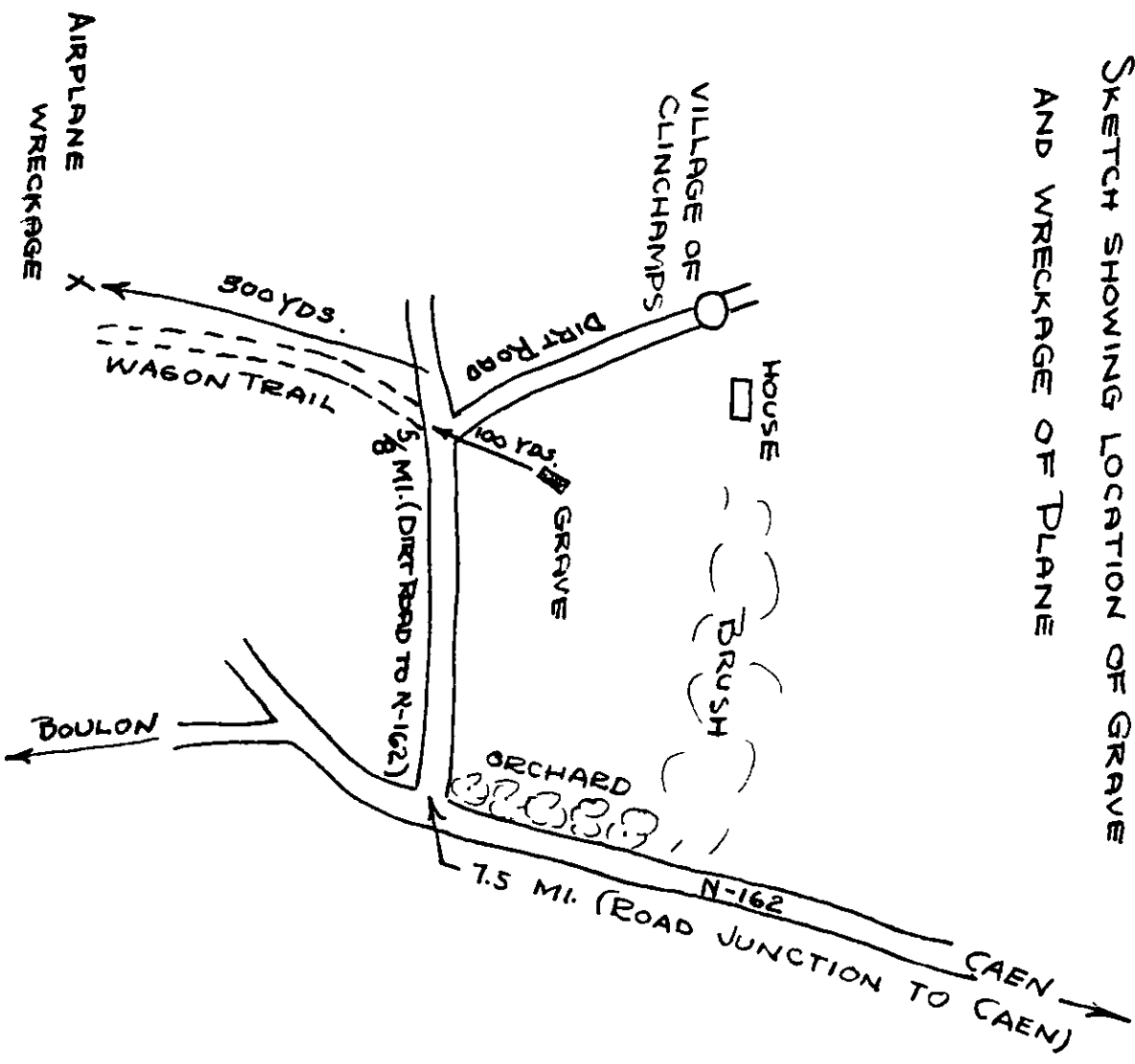

LT-
R-105
M-105
K-105

Arrived at cemetery 1400 1 Sept 1946 or

Place of death Clinchburg, Md. See sketch
(conditions and landmarks)

Remains recovered by 3058 Co. of 89th Co.
(name and organization)

Evacuated to cemetery by 3058 Co. of 89th Co.
(name and organization)

Is load list attached no from names of deceased found in same area as this
(yes-no)

Unknown starred no Are circumstances described which may indicate organization
(yes-no)

ion of the deceased yes If all, part of a body was received, was a careful
(yes-no)

search made for other parts of Unknown yes
(yes-no)

If remains came from vehicle, plane, etc. no
(type of vehicle or plane, nickname,

Serial No. 10668-1036
(serial number, organization or symbols)

Crew list None (names of other deceased and positions in which found.)

If a tank, which hatches were free and available for escape use _____

If organization to which vehicle or plane was assigned or if names of all other
deceased are not known, give available information concerning vehicle or plane

Yes Unable to determine
(parts of markings or symbols) (burned) (pierced by shell fire - where)

Field No
(found in town, field, by road, etc.) (damaged by mine explosion)

None None
(names of men who escaped) (description of other vehicles or planes in same area)

Detailed description of personal effects _____
(indicate exact pocket or part of body where found)

1 Ring, gold 14K (wedding)

*Head			
Raincoat			
Overcoat			
Jacket			
Jacket			
Coat			
Suit			
Jacket			
*Jacket			
Under shirt	None	White	Unable to determine
Under shirt	None	O D	Unable to determine
Trousers			
*Trousers			
Belt			
Drawers			
Drawers	None	O D	Unable to determine
Legging			
Socks			
Socks	None		Unable to determine
Overalls			
Overalls			
Flying suit	cotton		Unable to determine
Glove			Unable to determine

1. List of items, sizes of these items, etc. of the items.

2. Description of items, location, etc.

3. Description of items.

4. Size of items (height, weight, etc.)

5. **Body severely burned**

Fingers Unable to determine
(short, thick, long, slender, size of knuckles) (missing fingers or
joints) (unusual characteristics of fingernails)

Chest Unable to determine
(size of areolae, color, quantity & extent of hair, length, color, etc.)

Back Unable to determine Unable to determine
(character, and extent of hair) (size of navel, position, etc.)

Unable to determine Unable to determine Unable to determine Unable to determine
(yes-no) (color) (yes-no) (color)

Legs Unable to determine
(size of) (muscular, & back-knobs, bowls, normal) (quantity of hair) (color)

Feet Unable to determine Toes Unable to determine
(size of toes, phalanges, flat) (slender, upright, free of calluses)

Evidence of unusual features Unable to determine
(scars, ulcers, leg, etc.)

Black out marks of body
not received at any



Have photographs been made and attached? no If not, explain
(yes-no)

Have fingerprints been placed on cards? no If not, explain Unable to determine
(yes-no)

Has toe & chart been prepared? no If not, explain
(yes-no)

Remarks Parts of feet & hands missing lower
R. Jaw missing

Thomas J. Prue
Special Agent in Charge

Bandages or dressings Unable to determine Scars Unable to determine
 (location)

Tattoos Unable to determine
 (number, location - illustrate on sep page)

Outstanding moles, warts, or birthmarks Unable to determine
 (describe, location)

Sunburn or tan Unable to determine and face
 Tobacco stain on fingers or teeth

Complexion Unable to determine (designate where, extent, Build
 (light, med, dark, clear, pimples, pocks, freckles) (large, fat, thin
 Round small amount of hair - appears to be dark brown
 muscular)

Hair Unable to determine
 (color, length, quantity, curly, wavy, straight, whorls, or definite parting,
Unable to determine Unable to determine
 baldness, widow's peak, distinctive cutting, or other characteristics)

Sideburns Unable to determine Mustache Unable to determine Beard or goatee
 (color, setting, shape) (color, size, shape) length,
Unable to determine Unable to determine
 heavy, light, color, extent)

Eyes Unable to determine Eyebrows Unable to determine
 (color, setting, shape) (color, bushiness, extend across nose)

Nose Unable to determine Ears Unable to determine Unable to determine
 (size, shape, straight) (size, set close to or far from head)

Forehead Unable to determine Mouth Unable to determine Lips Unable to determine
 (high, wide, wrinkled) (large, medium, small) (small, large, full)

Teeth Unable to determine Unable to determine
 (white, size, unevenness, spacing, noticeable crowns, fillings, extractions)

Chin Unable to determine Cheekbones Unable to determine Unable to determine
 (prominent, receding, pointed, ample, double) (high, normal)

Jaw Unable to determine Circumference of head Unable to determine Unable to determine
 (large, small, normal) (hat band)

Neck Unable to determine Unable to determine Shoulders Unable to determine
 (size, long, short, normal, wrinkled) (prominent, normal) (broad)

Unable to determine Arms Unable to determine
 (straight, small, rounded) (length) (muscular, color, extent)

Unable to determine Hands Unable to determine
 (vaccination scars size of wrists) (large, small, normal, callused, normal)

(marks on fingers indicating that rings were worn)

QM-GR 293 (Blosville, E-1-3) 2nd Ind. WLF7-wjg
HEADQUARTERS, 306TH QUARTERMASTER BATTALION, APO 562, US ARMY 6 July 1945

To: Commanding Officer, 3058th QM Graves Registration Co, APO 562, US Army

Forwarded for compliance with basic communication.

By order of Lt Col HUNT:

W. L. FERSON
1st Lt, QMC
Adjutant

Incls: n/c

QM-GR 293 (Blosville, E-1-3) 3rd Ind. MRJ/ajb
HEADQUARTERS, 3058 QM GR Co, APO 562, U S ARMY. 12 July 1945

To: Commanding Officer, 306th QM Bn., APO 562, U S Army.

1. Attention is invited to inclosed check list and tooth chart prepared in compliance with basic communication.

For the Commanding Officer:



WILLARD R. JONES
1st Lt. / FA
Graves Registration Officer

2 Incls. in quadruplicate.

QM-GR 293 (Blosville-E-1-3) 4th Ind. WLF/wgm
HEADQUARTERS, 306TH QM BN, APO 562, US ARMY, 16 July 1945.

TO: Commanding General, Communications Zone, ETCUSA, APO 947, US ARMY. ATTN: CCOY.
(Thru Channels.)

For the Commanding Officer:

W. L. FERSON
1st Lt, QMC
Adjutant

2 Incls

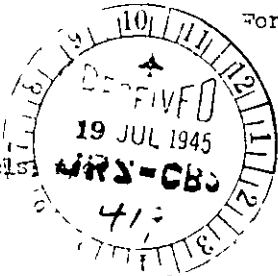

HEADQUARTERS
COMMUNICATIONS ZONE
EUROPEAN THEATER OF OPERATIONS
UNITED STATES ARMY
Office of the Chief Quartermaster
APO 887

RDP/mjg

Q-GRE (Blosville, E-1-3)

(S: 27 July 1945)
27 June 1945

SUBJECT: Request for Disinterment.

CHANOR

TO : The Graves Registration Officer, ~~Chanor~~ Base Section,
APO ~~562~~, U. S. Army.
228

1. Request the remains of John BESSEN, rank and serial number unknown, buried at Blosville American Military Cemetery, Plot E, Row 1, Grave 3, be disinterred and carefully examined for all clues that will aid in identification. The enclosed check lists and tooth charts will be completed in every respect and returned to this headquarters in quadruplicate.

2. No change will be made in the designation of the remains until further instructions are issued by this headquarters.

3. Request reply by indorsement to reach this headquarters not later than 27 July 1945.

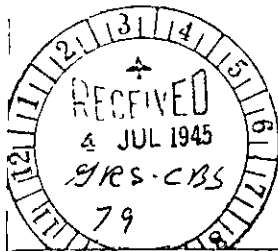

Philip J. Young
Capt. ord.
for JAMES W. YOUNGER,
Brigadier General, USA,

QM-GR 293 (Blosville, E-1-3) 5th Ind. JAS/s
OQM, Hq, Chanor Base Section, APO 562, U. S. Army, 20 July 1945.
To: Graves Registration Service Command, Hq, USFET, APO 887, U.S. Army.

For the Base Section Quartermaster:

Incls: n/c

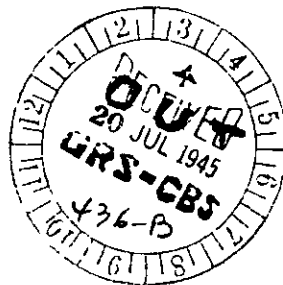

James A. Seuss
JAMES A. SEUSS
Capt., QMC
Assistant.

Q-1196

C-130

HEADQUARTERS
COMMUNICATIONS ZONE
EUROPEAN THEATER OF OPERATIONS
UNITED STATES ARMY
Office of the Chief Quartermaster
APO 887

4
ent
2
398
ea 82

RDP/mjg

Q-GRE (Blosville, E-1-3)

(S: 27 July 1945)
27 June 1945

SUBJECT: Request for Disinterment.

CHANOR

TO : The Graves Registration Officer, ~~Monmouth~~ Base Section,
APO ~~862~~, U. S. Army.
228

1. Request the remains of John BESSEN, rank and serial number unknown, buried at Blosville American Military Cemetery, Plot E, Row 1, Grave 3, be disinterred and carefully examined for all clues that will aid in identification. The enclosed check lists and tooth charts will be completed in every respect and returned to this headquarters in quadruplicate.

2. No change will be made in the designation of the remains until further instructions are issued by this headquarters.

3. Request reply by indorsement to reach this headquarters not later than 27 July 1945.

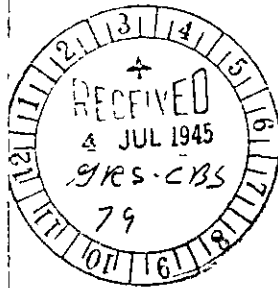

Philip J. May
Copy one
for JAMES W. YOUNGER,
Brigadier General, USA,
Chief, GR & E Division.

Incl.
Check List (in quin)

Q-GRE 893 (Blosville, E-1-3) 1st Inc. BAL/jom
Col., HQ. GRAVES BAS' SECTION, APO 862, U. S. ARMY. 6 July 1945.

TO: Commanding Officer, 306th G. Battalion, APO 862, U. S. Army.

For the Base Section Quartermaster.

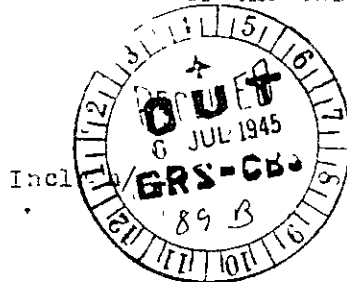

Incl

Wayne B. Starnes
2/2d Inc
for EDWIN A. LINDY
1st Lt., GOC
Assistant

SICG(Bleedville 5-1-3)

6th Ind.

PJW/RDP/gf.

(S: 18 September 45)

HR, HQ HEADQUARTERS OF THE 5TH AV, TRFT, (Rear), APO 887, U.S. ARMY, 18 August 1945.

TO: The Graves Registration Officer, Chaner Base Section, APO 562, U.S. ARMY.

1. Subject deceased cannot be definitely identified with available information at this time. Request remains to be assigned an Unknown X-number and corrected copies of Report of Burial forwarded to this Headquarters in quadruplicate. Each copy will note all clues that will aid in identification.

2. Attention is invited to paragraph 1, basic communication, which states that "the inclosed check lists will be completed in every respect."

3. Each piece of information available when disinterment is made should be carefully noted and, where positive answers cannot be given, estimates should be made. This is particularly true with regard to Parts II and III of the inclosed check lists.

4. Before correspondence is returned to this Headquarters, the check list will be completed in every detail and estimates made where positive answers cannot be given. Where information is not available, negative reply will be made.

5. Request reply by Indorsement to reach this Headquarters not later than 18 September 1945.

For the Director General:

F.C. MCGR, Captain, S.C. Adjutant.

Incl n/c.

DISTRIBUTION:
Orig & 9 Copies - Addressee
1 Copy - GR
1 Copy - S.File

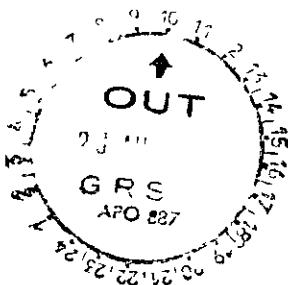

RAT
RDP
JW
PGW
JG
FCM



1	Interred 2 Apr 1949 A-9-25 USMC St Laurent				DISINTERMENT DIRECTIVE				
	C. H. HIEMSTRA 1st Lt, Inf, Interment Officer				DIRECTIVE NUMBER 3508 00000		DATE 15 11 47 DAY MONTH YEAR		
SECTION A - NAME AND BURIAL LOCATION OF DECEASED				SERIAL NUMBER UNKNOWN X-000196		RANK J		DATE OF DEATH DAY MONTH YEAR 3505 80	
CEMETERY BLOSVILLE - CAPENTAN				DISPOSITION OF REMAINS 0		CODE 3505		DIST PT 80	
PLOT E	ROW 1	GRAVE 3	COUNTRY FRANCE			CAUSE OF DEATH 6			
SECTION B - CONSIGNEE AND NEXT OF KIN									
NAME AND ADDRESS OF CONSIGNEE ST. LAURENT, FRANCE (BY ADMINISTRATIVE ORDER)					NAME AND ADDRESS OF NEXT OF KIN				
SECTION C - DISINTERMENT AND IDENTIFICATION									
NAME UNKNOWN			SERIAL NUMBER X-000196		RANK		DATE OF DEATH 15 Dec 47		DATE DISTINTERRED
IDENTIFICATION TAG ON <input checked="" type="checkbox"/> REMAINS <input checked="" type="checkbox"/> MARKER		ORGANIZATION USAGF			RELIGION		IDENTIFICATION VERIFIED BY R.W. Gansel, 1 Lt, QMC		
SECTION D - PREPARATION OF REMAINS FOR SHIPMENT									
NATURE OF BURIAL Mattress cover					CONDITION OF REMAINS Advanced decomposition				
OTHER MEANS OF IDENTIFICATION Burial bottle found on remains.									
MINOR DISCREPANCIES 1 None									
REMAINS PREPARED AND PLACED IN CASKET									
DATE 3 Feb 48				BY Jack B. Wall		EMBALMER (Signature) <i>Jack B. Wall</i>			
CASKET SEALED BY Jack B. Wall				SHIPPING ADDRESS VERIFIED BY Charles J. Missigman					
DATE 3 Feb 48				BY John E. Remy		SIGNATURE OF GRS INSPECTOR <i>Charles J. Missigman</i> Charles J. Missigman			
I hereby certify that all the foregoing operations were conducted and accomplished under my immediate supervision and that the report above is correct									
SIGNATURE OF GRS INSPECTOR									
1 Prepare Discrepancy Report QMC Form 1194a for major discrepancies									

RECORD OF CUSTODIAL TRANSFER

1 SHIPPED

FROM USMC Blosville		TO Casketing Point B - St Laurent	
KIND OF CONVEYANCE Truck		NAME OF CONVOYER Pvt Robert C. Spahn	
SIGNATURE OF SHIPPER <i>Wm T. Dailey</i> Wm T. Dailey, Capt QMC	DATE 27 Jan 48	SIGNATURE OF RECEIVER <i>Douglas A. Mackenzie</i> Douglas A. Mackenzie, Capt Inf	DATE 27 Jan 48

2 SHIPPED

FROM		TO	
KIND OF CONVEYANCE		NAME OF CONVOYER	
SIGNATURE OF SHIPPER	DATE	SIGNATURE OF RECEIVER	DATE

3 SHIPPED

FROM		TO	
KIND OF CONVEYANCE		NAME OF CONVOYER	
SIGNATURE OF SHIPPER	DATE	SIGNATURE OF RECEIVER	DATE

4 SHIPPED

FROM		TO	
KIND OF CONVEYANCE		NAME OF CONVOYER	
SIGNATURE OF SHIPPER	DATE	SIGNATURE OF RECEIVER	DATE

5 SHIPPED

FROM		TO	
KIND OF CONVEYANCE		NAME OF CONVOYER	
SIGNATURE OF SHIPPER	DATE	SIGNATURE OF RECEIVER	DATE

6 SHIPPED

FROM		TO	
KIND OF CONVEYANCE		NAME OF CONVOYER	
SIGNATURE OF SHIPPER	DATE	SIGNATURE OF RECEIVER	DATE

7 SHIPPED

FROM		TO	
KIND OF CONVEYANCE		NAME OF CONVOYER	
SIGNATURE OF SHIPPER	DATE	SIGNATURE OF RECEIVER	DATE

293 unk-France X-196 (Blossville) 14

HEADQUARTERS
MEDICAL REGIMENT REGIMENTAL HEADQUARTERS
THEATER SERVICE FORCES
EUROPEAN THEATER

AJC/IVa/rh

(Rear) APO 887.
10 November 1945

314.6

SUBJECT CR Form #1, Report of Burial. Transmittal Letter No.1709.

To The Quartermaster General, Washington 25, D.C.

1. Inclosed for your files is one (1) CR Form #1, GRS Report of Burial for Unknown X-196 buried in Plot B, Row 1, Grave 3, U.S. Military Cemetery, Blossville, France.

2. The remains buried in Plot A, now 1, Grave 3, were previously identified as John Bessen, however, upon disinterment no positive means of identification were found.

3. Further efforts will be made by this headquarters to establish the identification and the results will be furnished your office.

FOR THE COMMANDING GENERAL:

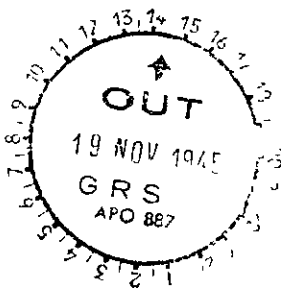

J. Krueger
I. KRUEGER,
WOJG., US4.,
Acting Adjutant.



g 6/10
Munich X 11/19 X Munich (Blossville)

NAIV
File 2180001
M Blossville
Adm. Br.

HEADQUARTERS
AMERICAN GRAVES REGISTRATION COMMAND
EUROPEAN AREA
APO 58 US ARMY

293
Unknown France X-196 / Blosville

1 March 1949
Date

SUBJECT: Unidentifiable Remains

TO The Quartermaster General
Memorial Division
Washington 25, D. C.

1. The records pertaining to Unknown X- 196, Plot E,
Row 1, Grave 3, USAC Blosville, France have been
reviewed and it is the opinion of this office that insufficient evidence
is available to establish the identity of this deceased, and that these
remains should be classified as unidentifiable.

2. Report of Reprocessing was forwarded to your office by
letter of transmittal No. 2116, dated 16 December 1946. No
further information is available.

~~XX~~

Case reviewed by undersigned Members of the Board of Review:

_____/s/_____
_____/u/_____

/s/ Capt Stanley C. Tyrrell, O-1304296 Inf

OQMG /s/ 1st Lt Edward E. Stout, O-1594512 CE

/s/ 1st Lt Ernest J. Oglesby, O-449004 Cav

Received 22 MAR 1949
Not identifiable from
information presently
available

NAT
file 3-29-49
Schmitt
Ident B7

THE DOUGLASS
GENERIC GRAVES REGISTRATION COMMISSION
EUROPEAN THEATRE OF OPERATIONS
APO 58 US ARMY

ARE 293

1 March 1949
(Date)

CERTIFICATE OF UNIDENTIFIABILITY OF REMAINS

The records pertaining to Unknown A-196, Plot E,
Row 1, Grave 3, US C BLOSVILLE, FRANCE,
have been reviewed and it is the opinion of this Office that sufficient
evidence is not available at the present time to establish the identity
of the deceased concerned. The remains concerned should be classified
as unidentifiable at the present time.

Report of reprocessing of remains was forwarded to your Office
by Transmitted Ltr. No. 2116, dated 16 December 1946

Case reviewed by undersigned members of the Board of Review:

----- *Stanley C. Tyrrell* -----
Capt. Jack C. H. YLS, O-1577297 G. C. Capt. Stanley C. TYRRELL, O-1304296 Inf

----- *Edward E. Stout* -----
Capt. Edward F. PRICE, Jr. O-1588236 G. C. 1/Lt. Edward E. STOUT, O-1594512 CE

----- *Ernest J. Cogleby* -----
1/Lt Ernest J. CGLEBY, O-449004 CW

Received 22 MAR 1949 OQMG
Unidentifiable from
information presently
available

Inc #1

TOOTH CHART

Blountville E-1-3

19 July 1945

X-196

Date

Last Name

First

Initial

Unk.
Rank

Unk.

Serial No

Unit

Organization

Place of Death

Date of Death

Cause of Death

Right

Left

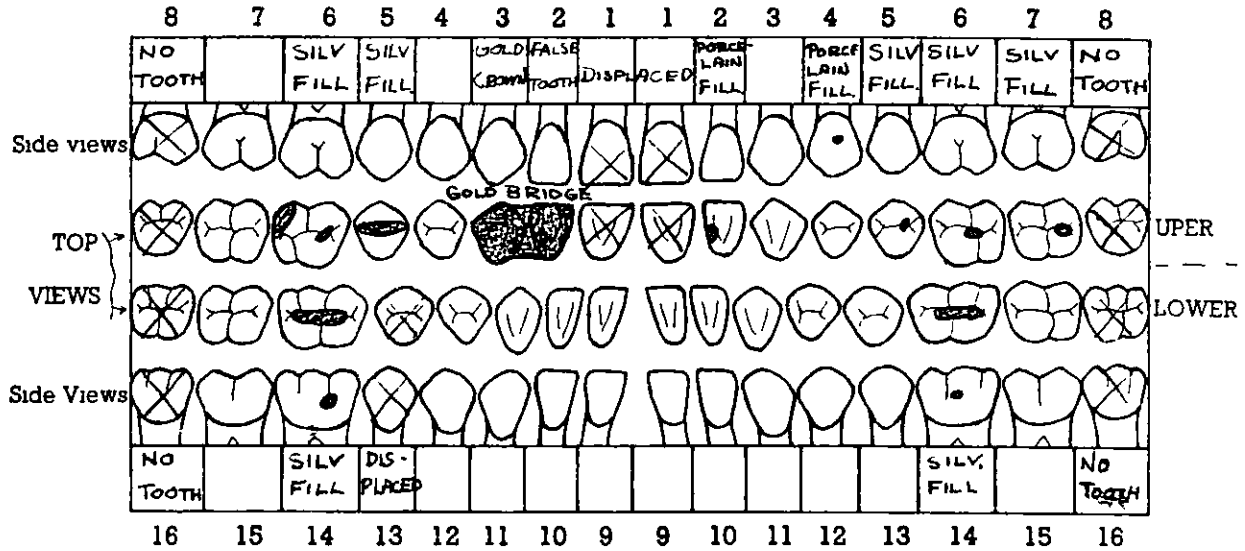

This dental chart is very important and should be filled in with great care. There are 32 teeth to be accounted for, as shown by the numbers on the chart. Beginning at the middle line in both upper and lower jaws, the teeth are arranged symmetrically on either side and classed as incisors (cutting teeth), cuspids or canines (tearing teeth), bicuspid (chewing teeth), and molars (principal chewing teeth). An examination should be made and findings charted to cover the following basic conditions: Lost teeth, crowned teeth, bridge work, fillings, caries (cavities of decay), dentures (plates), and any deformity of jaws found. See reverse side for illustrations.

No 3R appears to be beginning of gold bridge with two of teeth displaced, evidently one was an anchor tooth.

Signature of Officer or other person who prepared Tooth chart

THOMAS W. PARSONS

2nd Lt. - - - INF - - -

Verified by G R S Officer

MISSING TEETH All teeth missing through previous extraction (not those fractured or displaced by recent wounds) should be "X" 'd out and labeled, thus

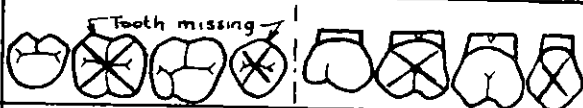

CROWNED TEETH Block in solid the crown of tooth (label gold, porcelain, Silver or gold and porcelain), thus

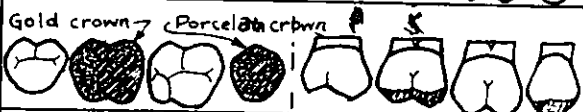

BRIDGE WORK Block in solid the crown of tooth (label gold bridge, gold and porcelain bridge), thus

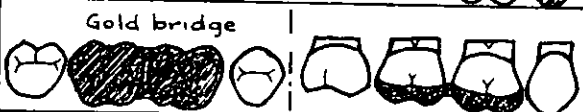

FILLINGS Draw filling on tooth as accurately as possible (block in and label gold, silver, cement), thus

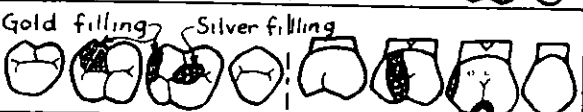

CARIES (CAVITIES) Outline location and size of cavity, shade in thus

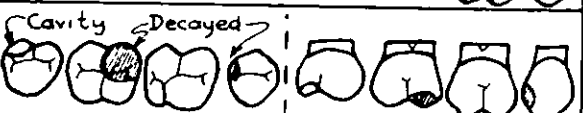

DENTURES (PLATES) Draw diagram of relative size and shape of plate, block in teeth attached and indicate retaining clasps on natural teeth with the word "clasp"

ADDITIONAL SPACE FOR FURTHER REMARKS

CHECK LIST OF UNKNOWNNS

(to be completely filled out and attached to each copy of Report of Interment
WD QMC Form 1012)

Unknown No. - 196
Cemetery **Bloisville**
Plot **E** - - Row **1** Grave **3**

- 1 ~~XXXXXXXXXXXX~~ **Reprocessed 4 November 1946**
(hours) (date)
- 2 Place of death _____
(name of closest town) (coordinate and letter; refer maps)
(Sheet, scale and serials used)
- 3 Remains ~~XXXXXXXXXXXX~~ disinterred by **Subordinate Identification Point, Carentan, France**
(name and organization)
- 4 Evacuated to Cemetery by _____
(name and organization)
- 5 **Description of clothing and equipment : (if clothes do not fit, obtain size from body measurements).**

Clothing Markings Sizes Indicate unusual markings
Color wear, tear repairs, etc

Item _____

*Headgear **Cap, HBT**
(type)

Raincoat **none**

Overcoat **none**

Ticket Field **none**

Ticket ~~XXXXXX~~ **Jump, paratroopers, 82 Airborne Div. Patch on left sleeve and remnants of
~~XXXXXXXXXX~~ American Flag on right arm**

Sweater **none**

Ticket HBI **none**

*Shirt Wool OD **none**

Undershirt Wool **one (1)**

Undershirt Cotton **none**

Trousers HBI **one pair, size W-32, L-33, marked in Waistband: P - 3101**

*Trousers Wool OD **none**

Belt Web - none

Drawers Wool one pair

Drawers Cotton none

Leggins, Wool none (Note unusual lacing)

Socks, ~~Cotton~~ wool, one pair

*Shoes --- (type) none

Overshoes --- none

Web Equipment (Type) none

(Other item) --- none

(Other item) --- none

*If body is nude, sizes of these items should be computed by measuring the remains

6 Chevrons or

Insignia --- none

(Type & location - shirt, jacket, coat, helmet)

Shoulder Patch **82 Airborne Patch and American Flag on sleeves of Jacket**

7 Does clothing indicate that deceased was a member of the Air, Ground or Naval Forces

Ground Forces

8 Description of Remains

Age **utd** Height ^{Est.} **5'4"** Weight **utd** Description of wounds **utd**

Bandages or dressings --- **utd** Scars --- **utd**
(date, width, location)

--- Tattoos **utd**
(Number, location - illustrate on sep. page)

Outstanding moles, warts or birthmarks --- **utd**
(yes/no, description, location)

Sunburn or tan other than hands & face --- **utd**

Complexion --- **utd**
(light, med, dark, clear, purple, pocks, freckle)

Build --- **utd**
(slender, thin, muscular)

Hair --- **light brown**
(color, length, quantity, curly, wavy, straight, wavy, or definite parting)

Hair **utd** _____ (childness widows peak distinctive cutting or other characteristics)

Sideburns **utd** _____ (color setting shape) Mustache **utd** _____ (color size shape) Beard or _____ **utd** _____ (length hoary)

Goatee **utd** _____ (high color extent)

Eyes _____ **utd** _____ (color setting shape) Eyebrows **utd** _____ (color bushiness even across nose)

Nose _____ **utd** _____ (size shape straight) Ears _____ **utd** _____ (size set close to or far from head)

Mouth _____ **utd** _____ (large medium small) Lips _____ **utd** _____ (small large full)

Teeth **See Tooth Chart** _____ (white size unevenness spacing noticeable crowns fillings extract)

Chin _____ **utd** _____ (prominent receding pointed dimple double)

Jaw _____ **utd** _____ (large small normal) (circumference of head in inches _____ **utd** _____ (hat band)

Neck _____ **utd** _____ (size length short normal wrinkled) Larynx _____ **utd** _____ (prominent normal)

Shoulders _____ **utd** _____ (broad straight small rounded) Arms _____ **utd** _____ (length muscular color)

_____ **utd** _____ (extent and quantity of hair)

Hands _____ **utd** _____

Fingers _____ **utd** _____ (short thick long slender size of knuckles missing fingers or joints)

_____ **utd** _____ (Unusual characteristics of fingernails)

Chest _____ **utd** _____ (size of nipples color quantity & extent of hair large small normal)

Back _____ **utd** _____ (quantity & extent of hair) Navel _____ **utd** _____ (size of navel appendectomy amount)

_____ **utd** _____ (quantity & color of hair) Circumcision _____ **utd** _____ (yes no) Pubic hair _____ **utd** _____ (color)

Hernia _____ **utd** _____ (yes no location)

Legs _____ **utd** _____ (instep muscular knock kneed bowed normal, quantity color & extent of hair)

Feet utd Toes utd
(size corns callouses flat) (slender straight crooked, overlap)

Evidence of healed fractures utd
(nose arms legs etc)

9 Black out parts of body not received at cemetery **See attached chart**

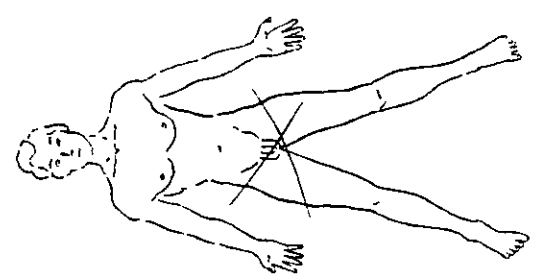

10 Have fingerprints been placed on Report of Interment no
(yes no)

If not, explain hands missing

11 Has tooth chart been prepared yes If not explain
(yes-no)

12 Remarks **Body received in mattress cover, fully clothed. Marking in waist band of HBT trousers P-3101. Body in chalky condition, measurements taken of Humerus, Femur and Tibia, and height of man estimated at 5'4". Fluoroscopic report "Negative. No burial bottle found in grave. Nothing found to warrant Chemical Laboratory Examination.**

I certify that I have personally viewed the remains of subject deceased and all resulting information has been recorded to the best of my knowledge

Robert A. Salvador

Robert A. Salvador *RAS*
Officer's Name

Captain Inf.
Rank Service

Central Identification Point
Organization

X-196

Slesville Cemetery, France
Flat E, Row 1, Grave 3.



TOOTH CHART

DATE

Unknown - 196

Last Name: Lot E, Row 1, Grave 3
First: Initial: Rank: Serial No.:
Unit: Organization:

Place of Death: Date of Death: Cause of Death:

Right



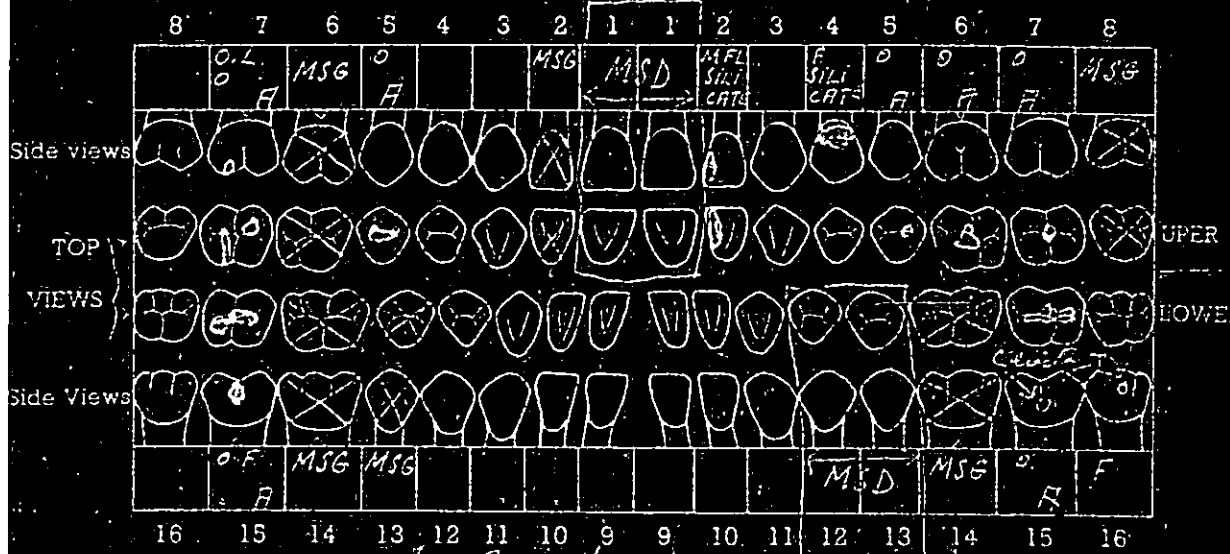

Left

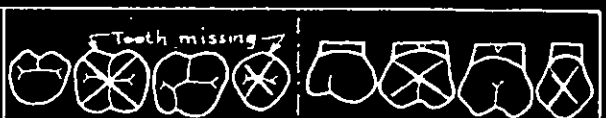

See Remarks

This dental chart is very important and should be filled in with great care. There are 32 teeth to be accounted for, as shown by the numbers on the chart. Beginning at the middle line in both upper and lower jaws, the teeth are arranged symmetrically on either side and classed as incisors (cutting teeth), cuspids or canines (tearing teeth), bicuspids (biting teeth), and molars (principal chewing teeth). An examination should be made and findings charted to cover the following basic conditions: Lost teeth, crowned teeth, bridge work, fillings, caries (cavities of decay), dentures (plates), and any deformity of jaws found. See reverse side for illustrations.

Lawrence W. Shaw M.D. D.D.
Secretary of Chief of Dental Service and Inspector of Dental Work
Robert J. ...
Checked by: G. E. S. Officer
Lieutenant W. S. ...

<p>MISSING TEETH... All teeth missing through previous extraction (not those fractured or displaced by recent wounds) should be "X" 'd out and labeled, thus :</p>	
<p>CROWNED TEETH... Block in solid the crown of tooth (label gold, porcelain, Silver or gold and porcelain), thus :</p>	
<p>BRIDGE WORK... Block in solid the crown of tooth (label gold bridge, gold and porcelain bridge), thus :</p>	
<p>FILLINGS... Draw filling on tooth as accurately as possible (block in and label gold, silver, cement), thus :</p>	
<p>CARIES (CAVITIES)... Outline location and size of cavity, shade in thus :</p>	

DENTURES (PLATES)... Draw diagram of relative size and shape of plate, block in teeth attached and indicate retaining clasps on natural teeth with the word "clasp."

ADDITIONAL SPACE FOR FURTHER REMARKS

Teeth are average size and a dull white color. Teeth are straight and well aligned except for R 9 of which the lingual surface overlaps the facial surface of L 9 about 1/16 of an inch. The facial surface of R 7 is rotated mesially about 1/8 of a turn.

R 2 and 6 both appear to have been extracted as does R 13 and 14 and L 14.

There is a space of 1/16 of an inch between R 3 and R 4, R 4 and R 5, and L 3 and L 4. There is a 1/8 of an inch space between R 5 and R 7.

6.5

COMPLETED JULY
REPORT OF BURIAL

1 July 1944
Date

REBERIAL: not good work...
 Unknown 7-194
 Last Name: _____ First Name: _____ Initial: _____ Rank: _____
 Unit: _____ Organization: _____
 Place of Death: France Date of Death: _____
 30 June 1944 (Reinterred) Bloisville France
 Cause of Death: KIA
 Time and Date of Burial: _____ Name of Cemetery: _____ Coordinates of Location: " 350 225
 Grave Number: 3 Row Number: _____ Type of Marker: 2022

Disposition of Identification Tags Buried with body Yes No Attached to Marker Yes No

If No Identification Tags Previously identified as "John Pessen" by Ltr. Hq. 655
 How were remains identified? Dated 24 June 1944, over signature Roy G. Osner
 357 Inf., A.C. This is believed to be a trooper. Identification not definite
 and assigned X No as per par 1, Otr. Ins. L. Theater G. Reg. Serv., 3321 (Rear)
 APO 887, 18 Aug. 45, Logic communication DTD 27 June 45, Hq. Comm. Z, ETO,
 U.S. Office of Chief of Chaplains, Bloisville, France (E-1-3)
 What means of identification were buried with the body? _____

GRS Tags X-190 were at Bloisville, buried with body and attached to marker.

To determine Right or Left use Deceased's Right and Left

Who is buried on Deceased's Right	Stallies, Charles, R. 32104116	Unk.	90th Div.	4
Deceased's Left	Agnewton, Alfred, L. 6945976	Unk.	Unk.	2

Signature of Name, Rank and if possible Organization of person furnishing above Data when other than officer reporting burial

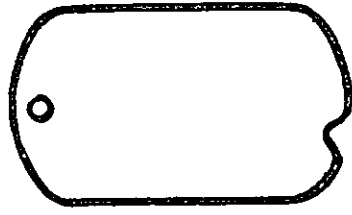

If print of identification tag is not affixed fill in below

Emergency Addressee: _____ Name: _____
 Address: _____
 Religion: UNKNOWN

List only Personal Effects Found on Body and disposition of same .
 NONE.

Signature of Officer or other person reporting burial
 THOMAS W. PARSONS
 and Lt. _____
 Verified by G.R.S. Officer _____

CHECK LIST FOR DISINTERMENT OF UNKNOWN

All questions should be answered. If a positive answer cannot be given, estimates should be made and indicated as such. If a reasonable estimate cannot be made, a negative answer should be stated.

UNKNOWN X- 196
CEMETERY Blossville
PLOT R ROW 1 GRAVE 8

PART I
Physical Description

1. Estimated height 5' 11"
2. Estimated weight 165 lbs
3. Color of eyes decomposed
4. Color of hair Black or Dark Brown pelvic Brown
5. Race White
6. Quantity and characteristics of hair on head (length, baldness, curly, etc.)
None on head
7. Amount and color of hair on body (nms, chest, pelvic region, legs)
A little adhering to clothes under arm pit brown
chest black or dark brown pelvic Region brown
8. Description of mustache and beard fresh on face decomposed
9. Length of sideburns Unable to determine
10. Was the deceased circumcised? penis decomposed
11. Are any tattoos or scars on the body? (Give description) skin on body
decomposed
12. Is there anything unusual about the fingernail structure?
no fingernails
13. Is there anything unusual in the construction of the toes or feet?
no only one foot
14. Was tooth chart taken? Yes Were fingerprints taken? No - decomposed
15. Proximate cause of death? severe shrapnel wounds chest and Rt. leg
16. Was the body burned? To what extent? no
17. Are any parts of the body missing or severed? yes, Rt. foot
18. Is there any evidence of first-aid or other medical treatment?
yes First aid dressing on chest
Lower part of rt. leg broken, skin splint on right leg (piece of 2x4)
19. If the remains are badly mangled, a careful search should be made for identification tags or personal effects. None found
20. If no clothing is found, measurements should be made of the head, neck, chest, waist, foot leg, (insect), and arm length in order that clothing sizes may be determined.

PART 11

Description and Sizes of Clothing

21. List every item of clothing found showing color of each.
22. List sizes of each item of clothing (if sizes are not shown, clothing measurements should be made or body measurements recorded as outlined in 20, above.
23. Report all clothing markings. Markings that are indistinct should be recorded as such.
24. Report all unusual or distinctive characteristics of clothing such as insignia, tears, repairs, wear, shortened leggings, unusual buttons, slits in shoes, etc.

<u>ITEM</u>	<u>REMARKS</u>
1 Para Jacket (NO 1)	no markings
1 Para Jacket (NO 2)	Right sleeve small cotton U S Flag at shoulder - Left sleeve #2 Air Borne Div. Patch
Jump Pants	On waistband R3101 Lettered by hand also stencilled on same waistband R301 (two middle No's illegible)
HBT Pants	32/33
HBT Belt	No markings
HBT Cap	No markings
Woolen undershirt	no markings
* Note para jacket (No 1) marking 0677	

This marking reported found on first disinterment & entered on previous check list.

PART 111

Measurements and Characteristics of Skeleton

(To be filled out only in cases where a skeleton or part of skeleton is found)

25. Length of foot _____
26. Width of foot _____
27. Length of arm (inseam) _____
28. Arm measurements for sleeve length _____
29. Circumference of skull _____
30. Length of fingers _____
31. Width of hand at knuckle _____
32. Length of skeleton _____
33. Size of bone structure (large, medium or small) _____
34. Evidence of bone scars indicating healed fractures _____
35. Unusual characteristics in bone structure _____

Are any parts missing or detached? In as much as this was not a skeleton and the head being the only part of remains that did not contain flesh, the above was the only measurement taken.

Investigation conducted by:

THOMAS W. PARSONS
2nd Lt INF

The findings of this disinterment have been compiled with the findings of previous disinterment submitted to your office. 3058th QM Graves Registration Co.